

HOLES TO BE CUTOUT
AS NEEDED TO ACCEPT
POLYLOK PRT. NO. 3001
D-BOX SEAL

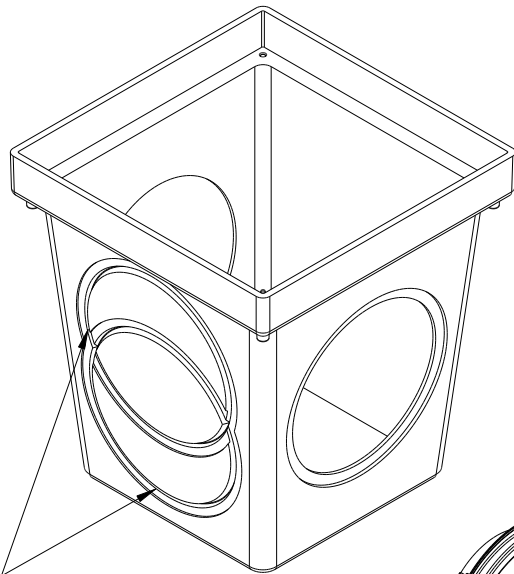

MODEL - PDB-9B
AS SHOWN WITH
2 SIDES WITH HOLES
2 SIDES WITH CUTOUTS

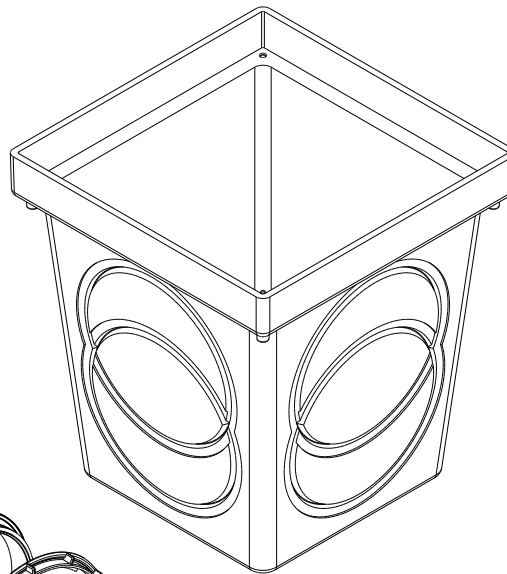

MODEL - PDB-9BL
AS SHOWN WITH
4 SIDES ALL CUTOUTS

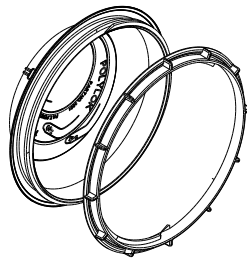

POLYLOK 9" DRAIN BOX
PART NO'S.
2- HOLE - PDB-9B
NO HOLE - PDB-9BL
GRATE - PDB-9G
MATERIAL - HDPE
COLOR - BLACK
GRATE:
32 SQ. IN. OPEN AREA
FLOW RATE - 41.92 GPM

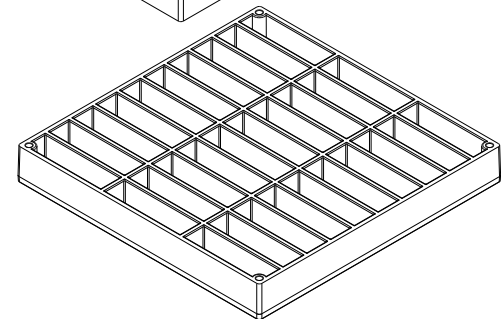
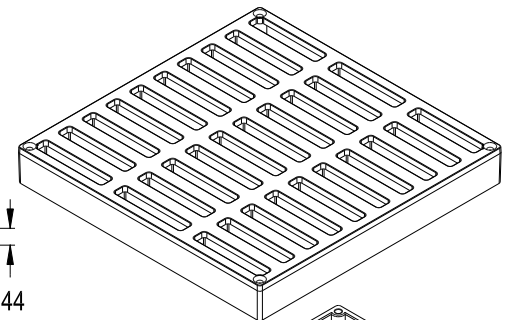
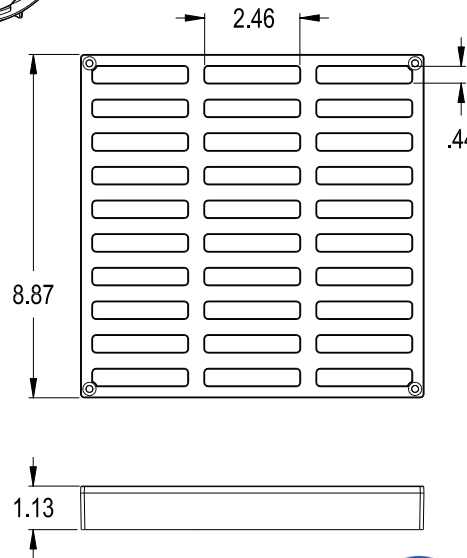
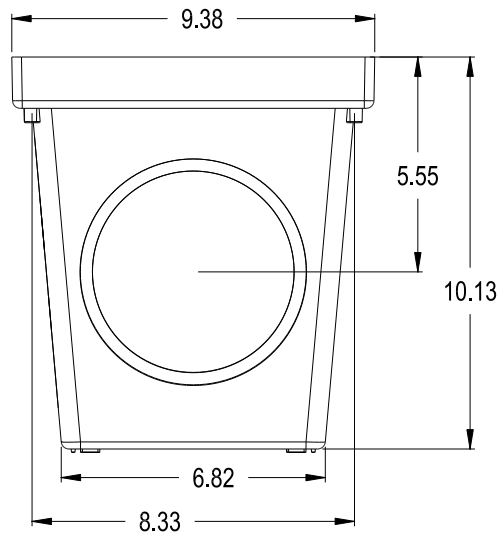
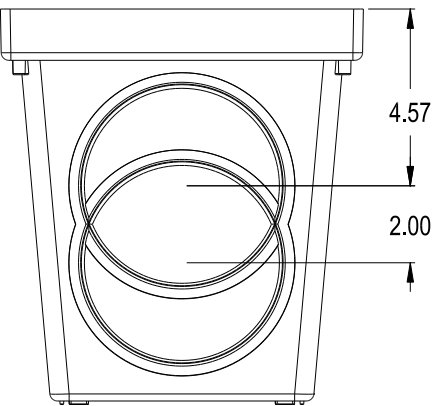

Ti SALES

36 Hudson Rd
Sudbury MA 01776



800-225-4616
www.tisales.com